

MITEL

Live Business Gateway



Technical Engineering Guidelines
Release 3.4 SP2

NOTICE

The information contained in this document is believed to be accurate in all respects but is not warranted by Mitel Networks™ Corporation. The information is subject to change without notice and should not be construed in any way as a commitment by Mitel or any of its affiliates or subsidiaries. Mitel and its affiliates and subsidiaries assume no responsibility for any errors or omissions in this document. Revisions of this document or new editions of it may be issued to incorporate changes.

No part of this document may be reproduced or transmitted in any form by any means – electronic or mechanical – for any purpose without written permission from Mitel Networks Corporation.

TRADEMARKS

Mitel and the Mitel Logo are registered trademarks of Mitel Networks Corporation.

VMware and VMware vSphere are registered trademarks of VMware Corporation.

Microsoft, Hyper-V, Windows, Windows Server, and Active Directory are registered trademarks of Microsoft Corporation.

Other product names mentioned in this document may be trademarks of their respective companies and are hereby acknowledged.

LIVE BUSINESS GATEWAY
Engineering Guidelines, Release 3.4 SP2

August 2013

®,™ Trademark of Mitel Networks Corporation
© Copyright 2013 Mitel Networks Corporation
All rights reserved

Contents

ABOUT THIS DOCUMENT	1
Glossary of Terms	2
SYSTEM OVERVIEW	2
System Configuration	3
Other Supported Deployments.....	4
SYSTEM REQUIREMENTS	5
Supported MCD Versions	5
Employing Multiple NICs.....	5
Security	6
Bandwidth Requirements.....	7
ENTERPRISE SITE CONFIGURATION	7
Supported User Desk Phones	7
Teleworker Phone Support	8
Hot Desk Support	8
Port Usage.....	8
VMware vSphere Support.....	9
VMware vSphere Management Tools.....	9
Microsoft Hyper-V Support	10
Microsoft Hyper-V Management Tools.....	11

MULTIPLE MCD SUPPORT 12

CLUSTERED NETWORK FLAG CONFIGURATION 13

INTEGRATION WITH LIVE BUSINESS GATEWAY RELEASE 3.4 13

SYSTEM RECOVERY 14

PERFORMANCE GUIDELINES 14

USABILITY GUIDELINES 14

About this Document

These engineering guidelines are provided to assist in the planning, installation, and implementation of Mitel® Live Business Gateway solutions in customer systems and will continue to evolve with product improvements, new features, and field experience. They should not be considered as a comprehensive list, but as factors to consider before you install and implement Live Business Gateway.

This document is intended for Mitel Channel Partners and sales engineers, application developers, technicians, and product support teams. It focuses on the performance impact of Live Business Gateway on Mitel Communications Director (MCD) 4.0 (SP4) and later and enables teams to properly define supported system configurations that involve numerous applications.

To access the Live Business Gateway documentation set, go to <http://edocs.mitel.com>.

 **Note:** You require a Mitel OnLine user name and password to access this site. Documentation from previous releases is stored under “Archives”.

To access product and technical documentation

1. Log on to Mitel OnLine.
2. Click **Technical**.
3. Select **Product Documentation**.
4. To access **IP Phone documentation**, click the "User Guide" or "Installation Guide" links at the top of the page.
5. To access **Live Business Gateway** documentation, in the left pane, locate “Applications and Solutions”. Click **Live Business Gateway**.

To access technical bulletins and release notes from the Mitel Knowledge Base

1. Log on to Mitel OnLine.
2. Click **Technical**.
3. Click **Knowledge Base**. The Knowledge Base search engine opens.
4. From the **Product** list, select **Live Business Gateway** and click **Search**.

The following guides provide complete information on Live Business Gateway:

- The *Live Business Gateway Installation and Maintenance Guide* details how to install and configure Live Business Gateway in the Windows environments.
- The *Live Business Gateway Engineering Guidelines* (this document) provides information about system architecture, requirements, and performance.

Glossary of Terms

Acronym	Description
ICP	Integrated Communications Platform
DND	Do Not Disturb
IP	Internet Protocol (RFC 1122 Section 3.)
MiNet	Mitel Network Layer Protocol – A layer 2 protocol used to transport messages between the PBX and all Mitel DNIC phones
NAT	Network Address Translation - a technique for translating one set of IP addresses, often private, to another set, often public (RFC 1631 – May'94)
M-TLS	Mutual – Transport Layer Security
QoS	Quality of Service
RTP	Real Time Protocol (RFC 1889)
SSL	Secure Socket Layer
TCP	Transmission Control Protocol (RFC 1122 Section 4.1)
UDP	User Datagram Protocol (RFC 1122 Section 4.1)
VoIP	Voice over Internet Protocol
VPN	Virtual Private Network

System Overview

The Mitel Live Business Gateway software application enables Microsoft® Lync Server 2010/2013 to communicate with MCDs, enabling the Lync client to take advantage of basic and supplementary phone services offered by MCD. Lync Server 2010/2013 monitors and controls Mitel phones connected to an MCD. Synchronizing Live Business Gateway with the corporate Active Directory server provides Lync user information.

 **Note:** Throughout this guide we refer to Lync Server 2010/2013, rather than Office Communications Server 2007/2007 R2. Live Business Gateway will continue to support Office Communications Server 2007/2007 R2.

Live Business Gateway is supported in a VMware® vSphere™ and Microsoft® Hyper-V™ environment enabling Live Business Gateway to run in a virtual environment.

Live Business Gateway can connect to up to 25 MCDs. Each MCD can connect to a maximum of five Live Business Gateways. One Microsoft® Windows Server® can connect to multiple Live Business Gateways (limits determined by Microsoft).

Live Business Gateway

- Enables users with Mitel desk phones to place and receive calls from Lync Server 2010/2013 and the Microsoft Office Suite.
- Provides enterprise presence information about users to the Lync Server 2010/2013 and the Office Suite (for example, Jane Doe is "on a call")

- Uses the industry standard SIP/CSTA protocol, which is simpler to understand than the MCD call control API.
- Enables desktop applications to use the following call control features:
 - Make Call
 - Answer Call
 - Clear Call
 - Deflect Call
 - Hold
 - Retrieve Call
 - Consultation Call
 - Transfer
 - Set Forwarding
 - Alternate Call

System Configuration

Communication between Lync Server 2010/2013 and MCD requires:

- Mitel 3300 ICP, MCD 4.0 SP4 or greater
- Microsoft Lync Server 2010/2013
- Microsoft® Active Directory® Server
- Mitel-supported phone (IP or DNIC)
- Layer 2 Ethernet Switch

Operating System:

- Microsoft® Windows Server 2003, 2003 R2 (SP2), or Windows 2008 R2

 **Note:** Microsoft Windows Server® 2008 R2 is a 64 bit O/S and is only supported on 64 bit servers. Microsoft Windows Server 2008 is not supported. Microsoft Windows 2000 Server Edition is no longer supported.

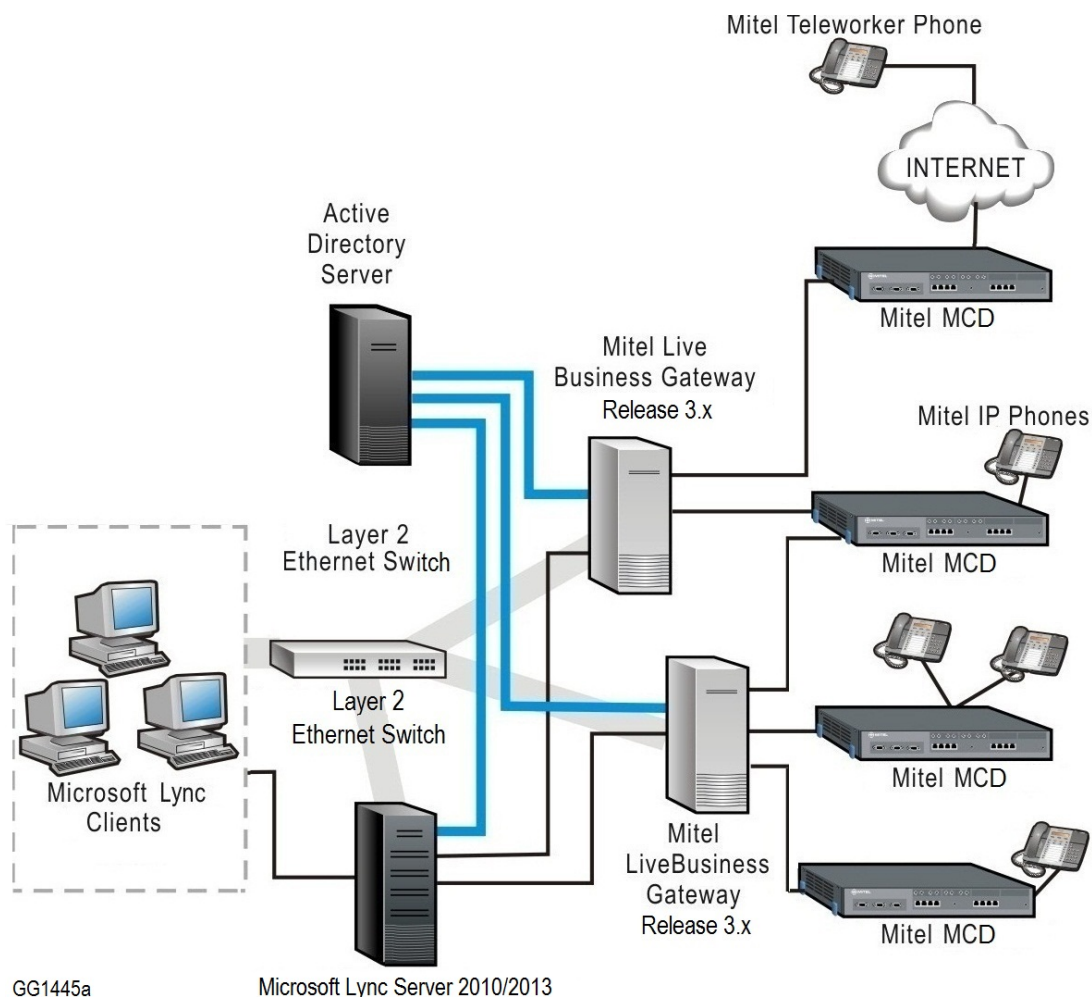



Figure 1: Typical Live Business Gateway Deployment

- 📄 **Note:** Live Business Gateway, Active Directory, and Lync Server 2010/2013 must be co-located with MCD. Do *not* deploy NAT devices or internet-facing firewalls between these components.
- 📄 **Note:** The VPN connection between Live Business Gateway and MCD has not been tested and is not recommended.

Other Supported Deployments

Live Business Gateway can be deployed in a number of configurations. For example, the Lync workstation in Figure 1 can be connected via VPN. Phones controlled by a VPN-connected Lync client may include remote Teleworker sets. For more information about remote Lync Server 2010/2013 configurations, go to Microsoft.com.

System Requirements

 **Note:** Live Business Gateway no longer supports Mitel Standard Linux (MSL). If you are upgrading from an earlier version of MSL Live Business Gateway, use the MSL to Windows (MslToWin) conversion utility to migrate data from the Live Business Gateway MSL server to the Live Business Gateway Windows server. See the *Live Business Gateway Installation and Maintenance Guide* for more information.

 **Note:** Live Business Gateway Release 3.2 or greater can be deployed on Quad Core Servers.

Live Business Gateway Release 3.4 has the following minimum system requirements:

Item	Requirements with 2,500 Users	Requirements with 10,000 users
CPU	X-86 Architecture, 1 GHz Processor	X-86 Architecture, 64 bit, 2.8 GHz Processor
RAM	2 GB	2 GB
Hard Drive	40 GB	40 GB
Configuration	Single Processor, Dual Processor, or Quad Core Processor	Single Processor, Dual Processor, or Quad Core Processor
NIC Card	Single or Multiple NIC cards	Single or Multiple NIC cards

Supported MCD Versions

Live Business Gateway supports the following MCD versions:

- MCD 6.0 SP2
- MCD 6.0 SP1
- MCD 6.0
- MCD 5.0 SP2
- MCD 5.0 SP1
- MCD 4.2 SP2
- MCD 4.1 SP2
- MCD 4.0 SP4

Employing Multiple NICs

Live Business Gateway supports multiple NIC cards. When multiple NICs are connected to the server, Live Business Gateway uses the NIC whose IP address is configured in the Live Business Gateway control panel applet for all communications.

LBG uses a single NIC for both incoming (from Lync) and outgoing (to Lync and to MCD) sockets. LBG uses the NIC whose IP address is configured on the LBG tab.

We recommend you configure Live Business Gateway on the primary IP address of the computer with multiple NICs to avoid licensing issues.

Live Business Gateway also supports multiple NIC cards when voice and data are on separate networks. Some sites with multiple NICs configure their server so that one NIC card is used for data and the other is used for voice. The Live Business Gateway configuration applet provides the ability to input two Live Business Gateway configuration IP addresses. In this case, one IP address is used to communicate with the Lync/OCS server and the other is used to communicate with MCDs. If only one NIC card is being used, then you must enter the same IP address in both input boxes (Data IP and Voice IP fields). Refer to the *Live Business Gateway Installation and Maintenance Guide* for more information and configuration instructions.

To move the NICs:

1. Click **Start>Run**, type **ncpa.cpl**, and click **OK**.

You can see the available connections in the LAN and High-Speed Internet section of the Network Connections window.

2. On the Advanced menu, click **Advanced Settings**.
3. On the **Adapters and Bindings** tab in the **Connections** group, select the connection that is to be moved higher in the list and use the arrow buttons to move the connection.

Security

Live Business Gateway has a built-in certificate for communication with MCD 4.0 SP4 or greater. This certificate can be revoked in a specific MCD or in a general release of MCD.

When communicating with MCD, Live Business Gateway uses SSL so the data is encrypted.

Live Business Gateway needs a security certificate. See the "Security Certificates for TLS" section of the *Live Business Gateway Installation and Maintenance Guide* for instructions on using certificates.

Live Business Gateway also communicates with Microsoft Active Directory. The Active Directory server must be in the same domain as Live Business Gateway for the default Live Business Gateway configuration to function.

In addition, a user account for the Live Business Gateway server must be entered in the Active Directory server of the domain. If the Active Directory server is located in a different domain, you need to configure the Active Directory tab in the Live Business Gateway Control Panel applet for Live Business Gateway to function. See the *Live Business Gateway Installation and Maintenance Guide* for instructions.

Bandwidth Requirements

10/100 Mbps Full Duplex Switched Ethernet

Table 1: Bandwidth Usage

# of Calls	Bandwidth Used
1	> 3 Kbps (basic): for example, a normal call
50	> 0.2 Mbps (basic)
100	> 0.3 Mbps (basic)
1	> 8 Kbps (large msg): for example, a conference call
50	> 0.5 Mbps (large msg)
100	> 1.0 Mbps (large msg)

Enterprise Site Configuration

When Mitel Live Business Gateway is installed on a Windows server running on the Enterprise LAN, no other software applications should be installed on the Live Business Gateway server.

Live Business Gateway must have IP connectivity to one or more MCDs with phones, one Microsoft Lync Server 2010/2013 and one or more Active Directory servers and must be able to resolve the Lync Server fully qualified domain name (FQDN).

Supported User Desk Phones

 **Note:** The Lync client is used to monitor and control only the prime line of Mitel phones.

Live Business Gateway supports the following phones (in MiNet mode only):

- 420 DNI Phone
- 4015 DNI Phone
- 4025 DNI Phone
- 4125 DNI Phone
- 4150 DNI Phone
- 5212 IP Phone
- 5215 IP Phone
- 5220 IP Phone
- 5224 IP Phone
- 5235 IP Phone
- 5240 IP Phone

- 5304 IP Phone
- 5312 IP Phone
- 5320 IP Phone
- 5320e IP Phone
- 5324 IP Phone
- 5330 IP Phone
- 5330e IP Phone
- 5340 IP Phone
- 5340e IP Phone
- 5360 IP Phone
- Navigator

Teleworker Phone Support

Teleworker users with the Lync client can monitor and control calls answered using the Teleworker phone. In this configuration, the remote user has a PC with the Lync client and a Teleworker phone. This configuration is based on Microsoft supporting the Lync client in a remote location. Go to Microsoft.com for more information.

 **Note:** This configuration requires a Microsoft Edge Server to front end Lync Server 2010/2013.

Hot Desk Support

Hot Desk users with the Lync client can control and monitor desk phones to which they are logged in.

Port Usage

You must install Live Business Gateway on a workstation within an enterprise (that is, Live Business Gateway *cannot* be used in the DMZ). Live Business Gateway does *not* provide firewall protection.

Table 2: Port Usage with Live Business Gateway

Port Range	Direction	Purpose
TCP 389 (LDAP)	LBG ↔ Active Directory	Active Directory access
TCP 7011 (SSL)	LBG ↔ MCD	Live Business Gateway to MCD Data Services
TCP 5060 (SIP)	Lync ↔ LBG	SIP connection (TCP) between Lync Server 2010/2013 and Live Business Gateway
TCP 5061 (SIP)	Lync ↔ LBG	SIP connection (TLS) between Lync Server 2010/2013 and Live Business Gateway

VMware vSphere Support

Live Business Gateway is supported in a VMware vSphere environment, which enables voice and business applications to run together in a virtual environment. Live Business Gateway is able to take advantage of the improved performance, ease of use, and comprehensive management capabilities of data center virtualization.

The key benefits for customers who deploy Live Business Gateway in a vSphere environment include:

- **Reduced capital expenditure:** Consolidation of Live Business Gateway as part of a virtual infrastructure enables businesses to further optimize server utilization. Dedicated physical servers (or appliances) are no longer required for Live Business Gateway deployments.
- **Reduced operation and maintenance costs:** Integration of Live Business Gateway within the fabric of vSphere virtual infrastructure management enables the solution to be managed cohesively alongside other virtualized business applications, further integrating IT processes and reducing maintenance costs.
- **Reduced power consumption:** Businesses can take advantage of the inherent power savings of virtual environments enabled by vSphere server virtualization—reduced servers and vSphere Distributed Power Management.
- **Integrated business continuity:** Consolidating Live Business Gateway within the management framework of a virtual data center environment enables the solution to take advantage of integrated disaster recovery management available through vSphere virtualization. Management methodologies and best practices are consistently applied across all applications in the data center saving the IT department time and money.
- **Consistent feature set and licensing:** Live Business Gateway deployed in a vSphere environment offers the same feature set and maintains the same product licensing options as Live Business Gateway deployed on a physical server. Familiarity of the solution is maintained for Mitel authorized PARTNERS and end customers.

Live Business Gateway is a standalone application that runs on Windows OS versions. Live Business Gateway is not supplied as a Virtual appliance (vApp); however, Live Business Gateway has been qualified in a VMware vSphere environment using VMware vSphere ESX or ESXi 4.0, 4.1, and 5.0.

Details of how to deploy Live Business Gateway in a VMware vSphere environment are outside the scope of the Live Business Gateway product documentation. Please refer to the relevant VMware vSphere product documentation for information on deploying applications in vSphere environments.

VMware vSphere Management Tools

The following VMware vSphere Management Tools from vCenter have been qualified with Live Business Gateway:

Power On, Shutdown Guest, Reset/Restart, and Snapshot

Live Business Gateway continues to function correctly when the virtual machine is rebooted or restarted by using the Power On, Shutdown Guest, Reset/Restart and Snapshot (Powered Off) management tools from vCenter.

Cloning

A clone is a copy of an existing virtual machine. The virtual machine on which Live Business Gateway is installed can be cloned using the vCenter management tool.

 **Note:** The AMC license is linked with the hardware ID of the virtual machine. The vSphere application assigns a new hardware ID to the cloned machine that fails to synchronize the license from the AMC server. Live Business Gateway needs to re-register the AMC license on the cloned virtual machine.

Cold Migration

vSphere Cold Migration focuses on reducing the total-migration time. When cold migration occurs, the virtual machine stops executing any programs currently working and copies the current page table to the machine where the virtual machine migrates.

 **Note:** The testing of cold migration has been limited to the same Host and Data store.

Health Monitoring and Performance Reports

Live Business Gateway is a standalone Windows application and is not directly affected by health monitoring and performance reporting. Live Business Gateway qualification testing confirmed that no extra memory resources are used by Live Business Gateway when these tests are run.

Microsoft Hyper-V Support

Live Business Gateway is supported in a Microsoft Hyper-V environment, which enables voice and business applications to run together in a virtual environment. Live Business Gateway is able to take advantage of the improved performance, ease of use, and comprehensive management capabilities of data center virtualization.

The key benefits for customers who deploy Live Business Gateway in a Hyper-V environment include:

- **Reduced capital expenditure:** Consolidation of Live Business Gateway as part of a virtual infrastructure enables businesses to further optimize server use. Dedicated physical servers (or appliances) are no longer required for Live Business Gateway deployments.
- **Reduced operation and maintenance costs:** Integration of Live Business Gateway within the fabric of Hyper-V virtual infrastructure management enables the solution to be managed cohesively alongside other virtualized business applications, further integrating IT processes and reducing maintenance costs.

- **Reduced power consumption:** Businesses can take advantage of the inherent power savings of virtual environments enabled by Hyper-V server virtualization—reduced servers and Distributed Power Management.
- **Integrated business continuity:** Consolidating Live Business Gateway within the management framework of a virtual data center environment enables the solution to take advantage of integrated disaster recovery management available through Hyper-V virtualization. Management methodologies and best practices are consistently applied across all applications in the data center saving the IT department time and money.
- **Consistent feature set and licensing:** Live Business Gateway deployed in a Hyper-V environment offers the same feature set and maintains the same product licensing options as Live Business Gateway deployed on a physical server. Familiarity of the solution is maintained for Mitel authorized PARTNERS and end customers.

Live Business Gateway is a standalone application that runs on Windows OS versions. Live Business Gateway is not supplied as a Virtual appliance (vApp), however, Live Business Gateway has been qualified in a Microsoft Windows Server 2008 R2 Hyper-V environment.

Details of how to deploy Live Business Gateway in a Hyper-V environment are outside the scope of the Live Business Gateway product documentation. Please refer to the relevant Microsoft Hyper-V product documentation for information on deploying applications in Hyper-V environments.

Microsoft Hyper-V Management Tools

The following Hyper-V Management Tools have been qualified with Live Business Gateway:

- Shutdown Guest
- Save
- Pause
- Reset
- Snapshot
- Live Migration

Multiple MCD Support

When multiple MCDs are connected, Live Business Gateway needs a SIP message from Lync Server 2010/2013 to indicate the destination ICP. The SIP message uses the information configured in the Remote Call Control section of Active Directory.

Multiple ICP support requires that the Active Directory configuration include the MCD address, (for example, pbx3.lbg3@mitel.com). Figure 2 shows a multiple MCD deployment and the Remote Call Control configuration for a particular MCD.

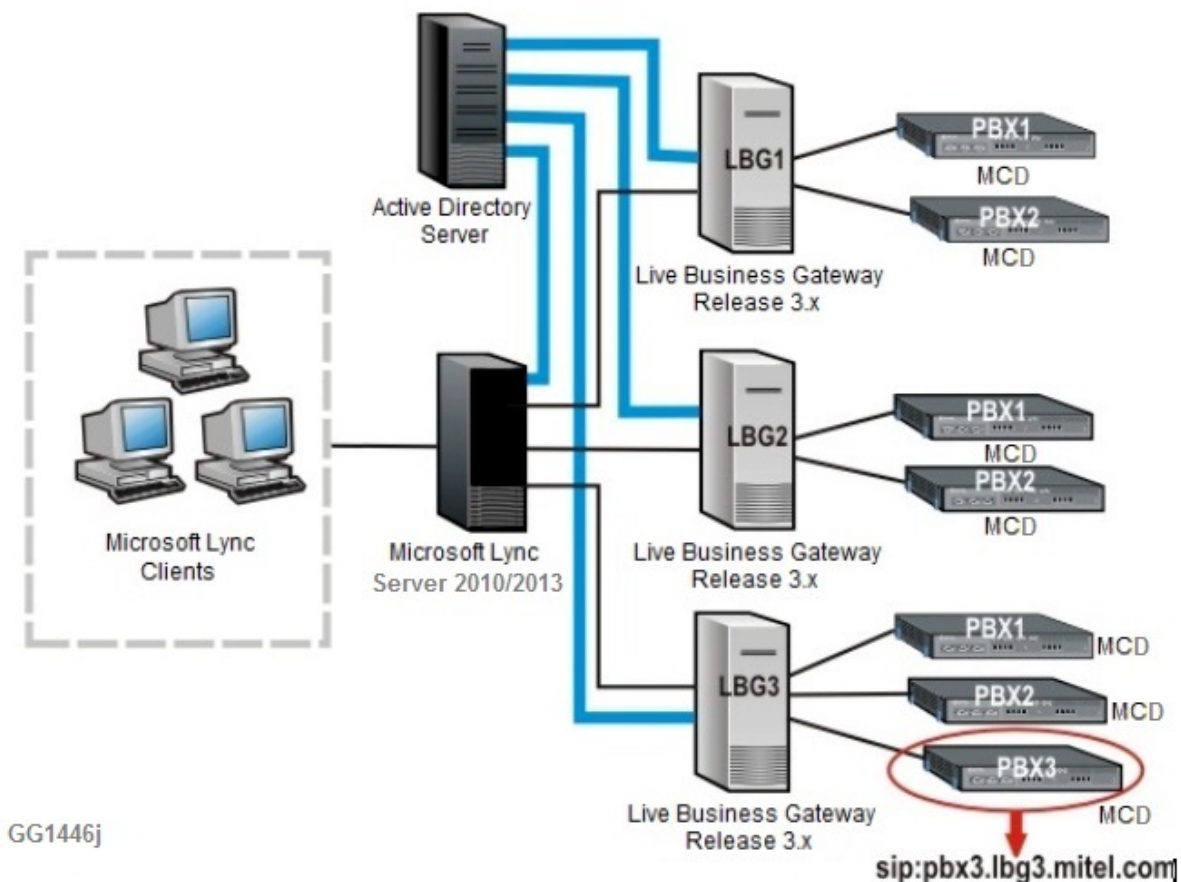



Figure 2: Multiple MCD Support

Clustered Network Flag Configuration

The Clustered Network flag on the ICP tab of Live Business Gateway configuration interface must be set properly based on the MCD cluster configuration. If all of the MCDs connected to the same Live Business Gateway are members of the same cluster (that is, where each DN is unique), then the Clustered Network flag should be **enabled**. If the ICPs are networked (DNs are not unique – they may be repeated on another node ID), the flag should be **disabled**.

 **Note:** Live Business Gateway 3.4 cannot communicate with more than one clustered MCD environment.

Integration with Live Business Gateway Release 3.4

Live Business Gateway releases 3.3 and 3.4 can co-exist, although Mitel would recommend upgrading to the latest release to take advantage of enhancements and bug fixes.

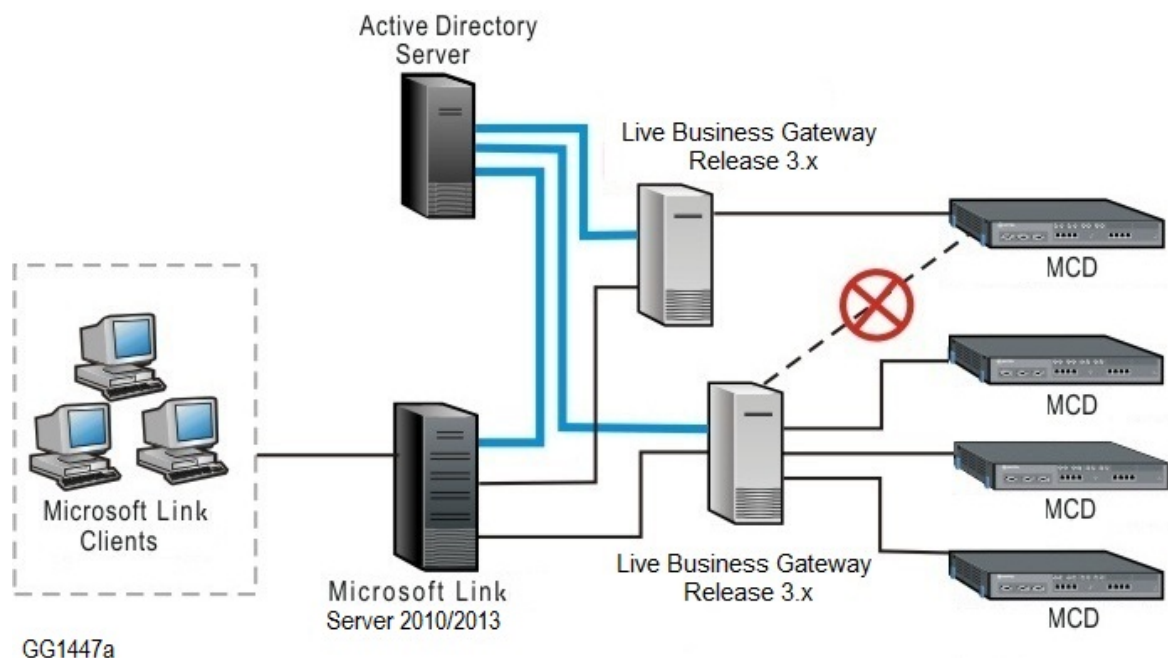

Figure 3: Interaction of Live Business Gateway Release 3.4

System Recovery

When the MCD server resets, the Lync client loses its connection to the MCD and does not respond. The Lync client continues to attempt connection at the following intervals:

Attempt	Time Elapsed Since Last Attempt
2	One minute
3	Three minutes
4	Five minutes
5	Ten minutes
6	Twenty minutes

For example, if the MCD reset takes ten minutes to complete, the Lync client can auto-sign in successfully on its fifth attempt.

Performance Guidelines

A Live Business Gateway running with minimum specified hardware requirements supports a maximum of 10,000 Lync users across 25, MCDs with average MCD call traffic at 10,000 calls per hour across the Lync clients.

 **Note:** Other applications, phone types, and MCD features impact MCD performance. See the *3300 ICP Engineering Guidelines* for more detailed information about MCD system configurations.

 **Note:** The phone type has an impact on the number of MCD phone monitors supported. For example, a 5235 IP phone will use two monitors if controlled and monitored using the Lync client (that is, one for Lync and one for internal applications in the phone itself).

Usability Guidelines

In Live Business Gateway Release 3.4, the Lync client supports a subset of MCD call features: not all call features accessed on Mitel phones are supported in the Lync client. See “System Overview” on page 3 for more information.

The *Live Business Gateway Installation and Maintenance Guide* provides a troubleshooting section that defines:

- Common system behaviors not supported when using the Lync client to control and MCD phones,
- Recovery scenarios for such behaviors.

GLOBAL HEADQUARTERS	U.S.	EMEA	CALA	ASIA PACIFIC
Tel: +1(613) 592-2122 Fax: +1(613) 592-4764	Tel: +1(480) 961-9000 Fax: +1(480) 961-1370	Tel: +44(0)1291-430000 Fax: +44(0)1291-430400	Tel: +1(613) 592-2122 Fax: +1(613) 592-7825	Tel: +61(0) 2 9023 9500 Fax: +61(0) 2 9023 9501

FOR MORE INFORMATION ON OUR WORLDWIDE OFFICE LOCATIONS, VISIT OUR WEBSITE AT MITEL.COM/OFFICES

THIS DOCUMENT IS PROVIDED TO YOU FOR INFORMATIONAL PURPOSES ONLY. The information furnished in this document, believed by Mitel to be accurate as of the date of its publication, is subject to change without notice. Mitel assumes no responsibility for any errors or omissions in this document and shall have no obligation to you as a result of having made this document available to you or based upon the information it contains.

M MITEL (design) is a registered trademark of Mitel Networks Corporation. All other products and services are the registered trademarks of their respective holders.

© Copyright 2012, Mitel Networks Corporation. All Rights Reserved.

mitel.com

